

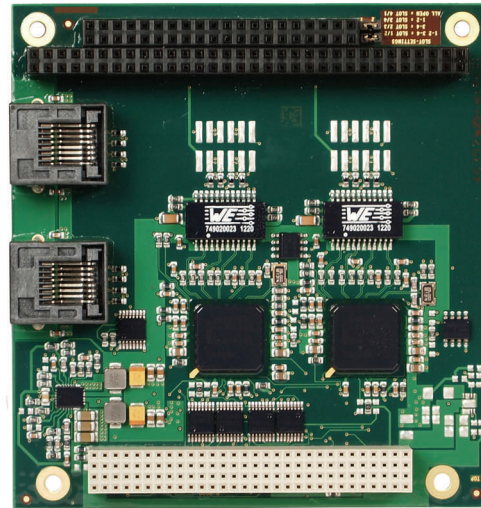

ADLLAN-2 PC/104-Plus Dual Ethernet LAN

Features

- PCI Based Ethernet LAN Card for PC/104-Plus
- Dual Intel 82541ER Gigabit Ethernet LAN Controllers Support Connection Speeds of 10/100/1000 Mbps
- Enhanced Power Management for Reduced Power Applications
- Dual Port Model Uses Two PCI Loads (slots)
- High-Performance PHY Technology Meets IEEE 802.3ab Specifications
- Footprint Compatibility with Other Intel PRO Connections for Flexible Designs
- Top and Bottom Stacking PC/104-Plus Pass-Through Connectors for Ease of Stack Configuration
- Optional Connection Headers for Cabling Embedded Applications
- Jumper Configurable PCI Load Selection for Flexible Integration with Other Peripherals
- Temperature Range -40C to +85C



Description

The Intel 82541ER Gigabit Ethernet Controller provides optimized Gigabit networking for PCI designs. This highly efficient controller, with enhanced power management, consumes less than 1.0W of power at Gigabit speeds. When no signal is detected on the wire, the controller reduces power consumption by “downshifting” to 100Mbps to 10Mbps and then powering down the physical-layer circuitry (PHY). When a signal is detected, the controller automatically negotiates the connection to Gigabit, if available.

The Intel 82541ER combines Intel’s fifth-generation Gigabit MAC design with fully integrated state-of-the-art PHY technology, which meets or exceeds IEEE 802.3ab specifications for Bit Error Rate performance.

Ordering Information

Item Code	Part #	Description
ADLLAN-2	299922	1Gbit dual port LAN board

Data subject to change without notice

ADL Embedded Solutions Inc., 4411 Morena Blvd., Suite 101 San Diego, CA 92117-4345

P. +1 858 490-0597 F. +1 858 490-0599
e-mail: sales@adl-usa.com; web: www.adl-usa.com



ADLLAN-2 PC/104-Plus Dual Ethernet LAN

Block Diagram

The ADLLAN is a PCI – based dual port Gigabit Ethernet LAN card that utilizes the Intel 82541ER Ethernet LAN controller. It is built in accordance with the PC/104-Plus specification and includes top and bottom PC/104 and PC/104-Plus connectors. The board is also equipped with PCI slot selection jumpers that allow for easy integration with other PC/104-Plus stackable peripherals. The ISA bus connector is included to pass the ISA bus through the board to ISA peripherals that may be included in the stack. The board comes equipped with onboard low profile RJ45 connectors for quick connecton to a network. The ADLLAN can optionally be populated with with locking pin headers for customers who require alternate cabling for embedded applications.

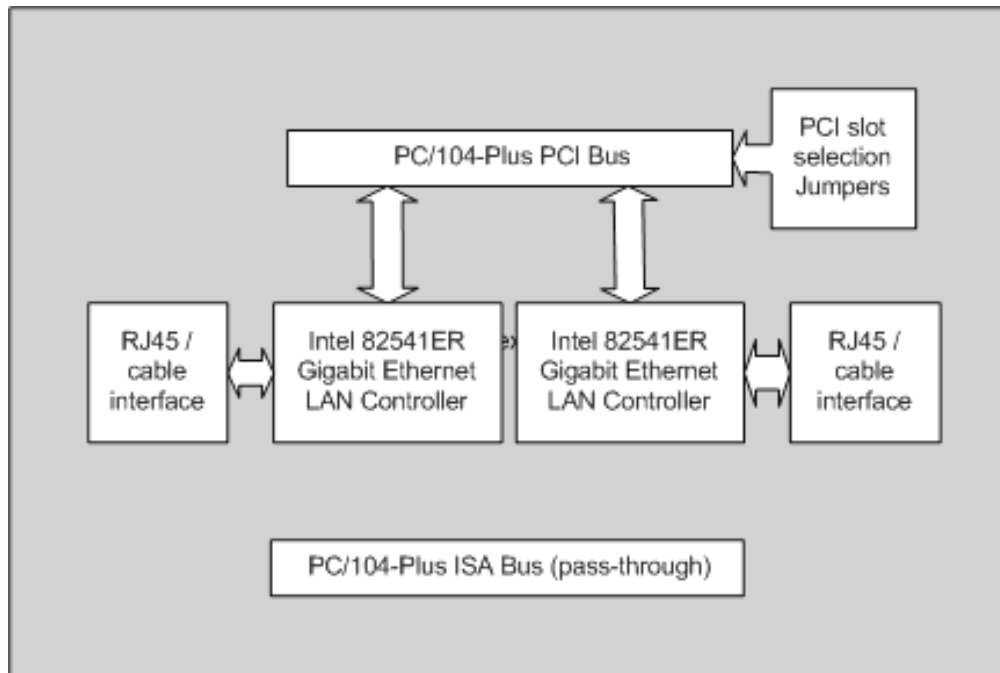

- Two Intel® 82541ER Gigabit Ethernet LAN Controllers
- PCI bus via PC/104-Plus (max. four master devices)
- ISA Bus pass-through
- PCI slot selection jumpers
- Dual port requires two PCI masters
- Onboard low profile RJ45 connectors
- Optional pin-header configuration available
- Size: 96 mm x 90 mm

Data subject to change without notice

ADL Embedded Solutions Inc., 4411 Morena Blvd., Suite 101, San Diego, CA 92117-4345

P. +1 858 490-0597 F. +1 858 490-0599
e-mail: sales@adl-usa.com; web: www.adl-usa.com



ADLLAN-2 PC/104-Plus Dual Ethernet LAN

Connector Map

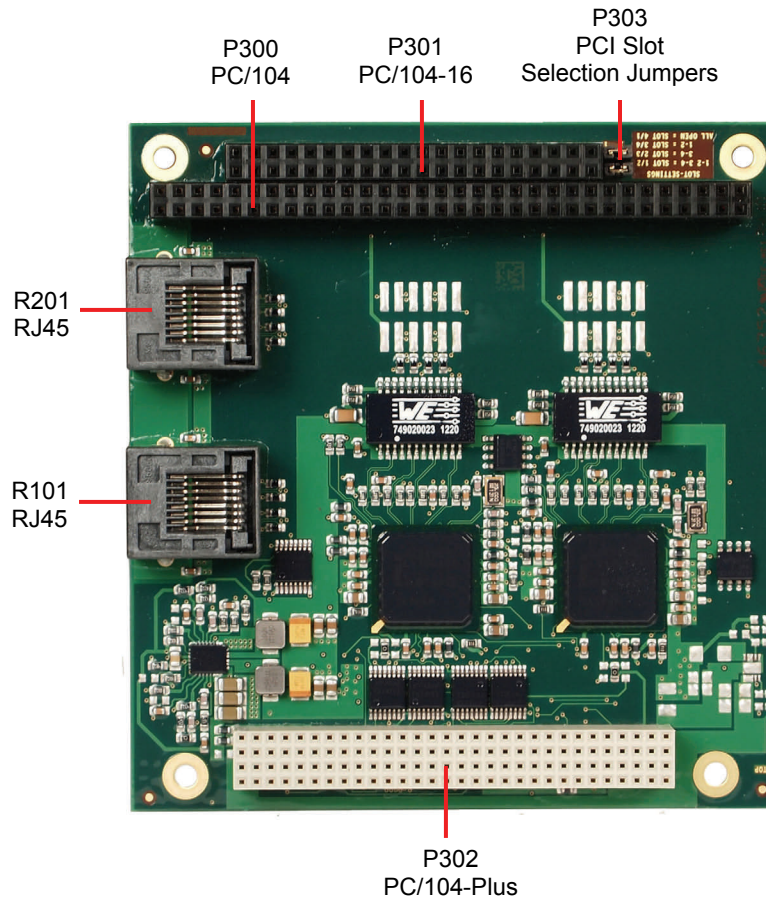

Ref-No.	Function
P302/P303	PC/104-Plus Bus
P300/P301	PC/104-Bus
P100/P200*	LAN Pin Header (not shown)
P101/P201	LAN RJ45

Data subject to change without notice

ADL Embedded Solutions Inc., 4411 Morena Blvd., Suite 101, San Diego, CA 92117-4345

P. +1 858 490-0597 F. +1 858 490-0599

e-mail: sales@adl-usa.com; web: www.adl-usa.com



ADLLAN-2 PC/104-Plus Dual Ethernet LAN

LAN Header

Both LAN interfaces are provided via optional 2x6pin connector (FCI 98424-G52-12LF, mating connector e.g. FCI 90311-012LF). The interfaces support 10BaseT, 100BaseT, and 1000BaseT compatible network components with automatic bandwidth selection. Additional outputs are provided for status LEDs. Auto-negotiate and auto-cross functionality is present. Development cables are available.

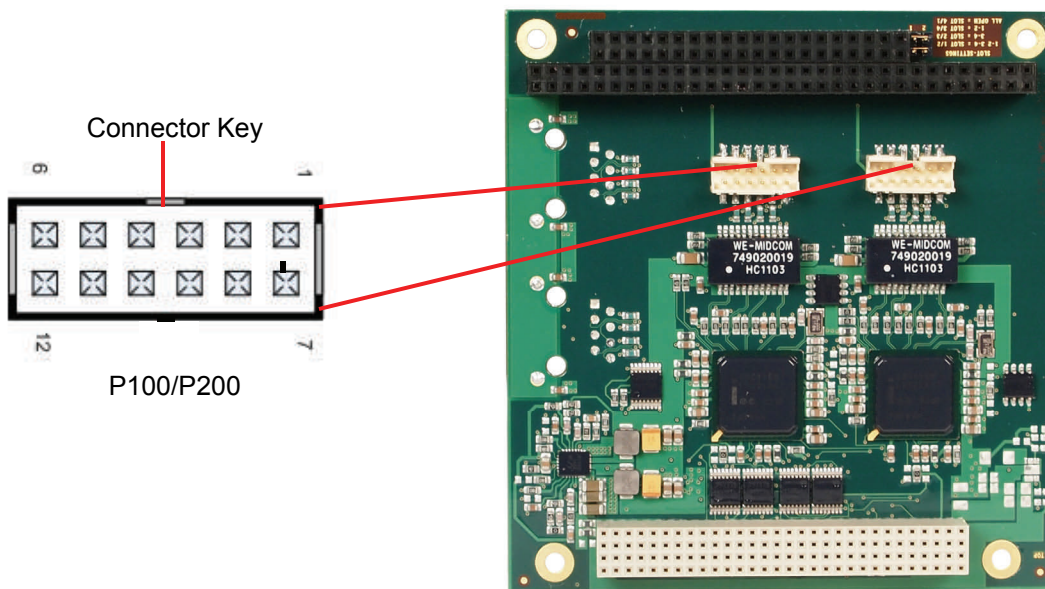

P100 / P200 Pinout LAN interface:

Description	Name	Pin	Name	Description	
LAN activity	LINKACT	1	7	SPEED1000	LAN speed 1000Mbit
LAN channel 1 plus	LAN1	2	8	LAN0	LAN channel 0 plus
LAN channel 1 minus	LAN1#	3	9	LAN0#	LAN channel 0 minus
LAN channel 3 plus	LAN3	4	10	LAN2	LAN channel 2 plus
LAN channel 3 minus	LAN3#	5	11	LAN2#	LAN channel 2 minus
LAN speed 100Mbit	SPEED100	6	12	3.3V	3.3 volt supply

Data subject to change without notice

ADL Embedded Solutions Inc., 4411 Morena Blvd., Suite 101, San Diego, CA 92117-4345

P. +1 858 490-0597 F. +1 858 490-0599

e-mail: sales@adl-usa.com; web: www.adl-usa.com



ADLLAN-2 PC/104-Plus Dual Ethernet LAN

LAN RJ45

Both LAN interfaces are standard populated with low profile RJ45 connectors onboard. The interfaces support 10BaseT, 100BaseT, and 1000BaseT compatible network components with automatic bandwidth selection.

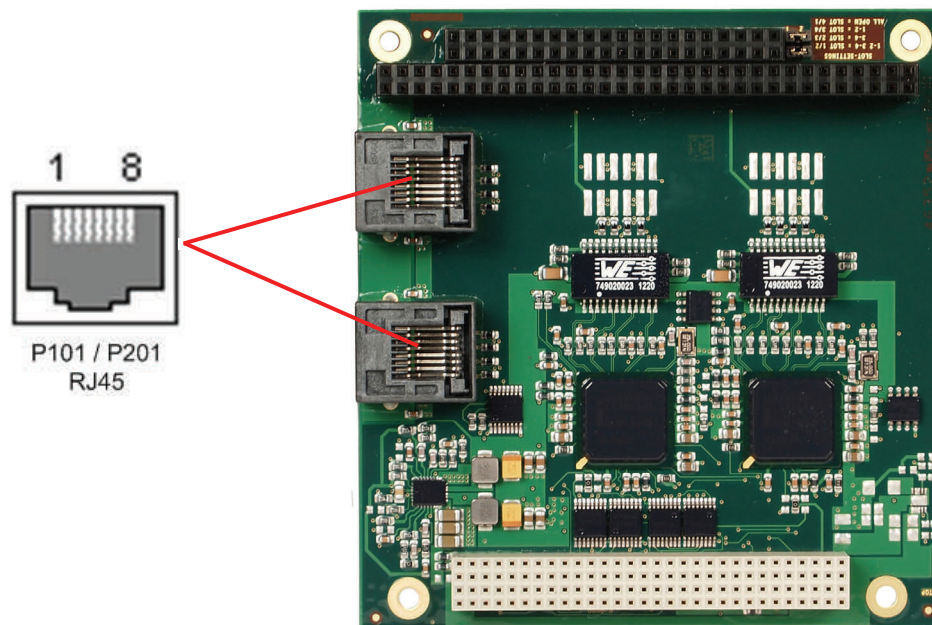

Pinout P101 / P201:

Description	Name	Pin
LAN channel 0 plus	LAN0	1
LAN channel 0 minus	LAN0#	2
LAN channel 1 plus	LAN1	3
LAN channel 2 plus	LAN2	4
LAN channel 2 minus	LAN2#	5
LAN channel 1 minus	LAN1#	6
LAN channel 3 plus	LAN3	7
LAN channel 3 minus	LAN3#	8

Data subject to change without notice

ADL Embedded Solutions Inc., 4411 Morena Blvd., Suite 101, San Diego, CA 92117-4345

P. +1 858 490-0597 F. +1 858 490-0599

e-mail: sales@adl-usa.com; web: www.adl-usa.com



ADLLAN-2 PC/104-Plus Dual Ethernet LAN

Board Configuration

Before the ADLLAN board can be installed onto a stack, the PCI slot Setting Jumpers (P303) must be installed to properly set the PCI loads to match the physical stack location on the PCI bus. For example, if the ADLLAN is to be the first PCI board closest to the CPU, then a jumper shunt should be installed on 1-2 and 3-4, or all jumpers can remain open. Reference the table below or on the ADLLAN card to properly configure the ADLLAN PCI bus.

NOTE

The ADLLAN requires two PCI slots (masters). The PCI slot configuration jumpers must be properly set prior to use. Two other PCI masters may be installed in the PCI stack with the dual port ADLLAN.

Device Drivers are available at: www.adl-usa.com

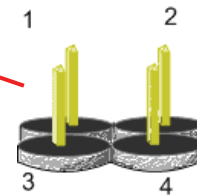
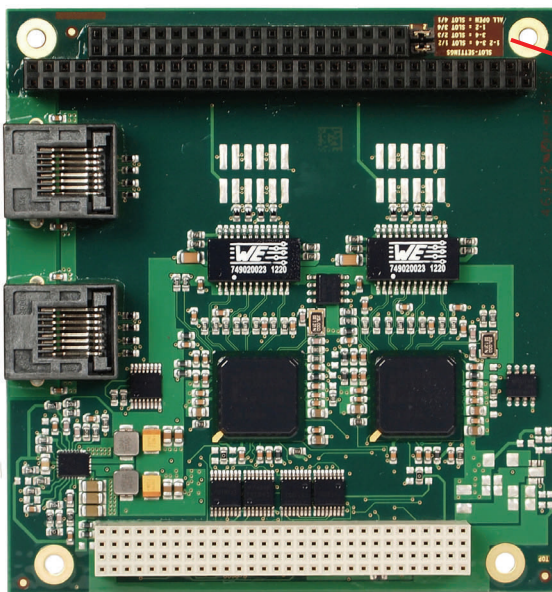

P303 PCI Slot Selection Jumper

Jumper Table P303:

Jumpers installed on:	Slot Settings
1-2 and 3-4	1 and 2
3-4 only	2 and 3
1-2 only	3 and 4
ALL OPEN	4 and 1

Data subject to change without notice

ADL Embedded Solutions Inc., 4411 Morena Blvd., Suite 101, San Diego, CA 92117-4345

P. +1 858 490-0597 F. +1 858 490-0599

e-mail: sales@adl-usa.com; web: www.adl-usa.com